



BUREAU VERITAS

Test Report No.: CE200109N021-2



Certificate # 2951.01

TEST REPORT



Applicant	Shenzhen SOFAR SOLAR Co., Ltd.
Address	401, Building 4, AnTongDa Industrial Park, District 68, XingDong Community, XinAn Street, BaoAn District, Shenzhen, Guangdong. P.R.China.

Manufacturer or Supplier	Shenzhen SOFAR SOLAR Co., Ltd.	
Address	401, Building 4, AnTongDa Industrial Park, District 68, XingDong Community, XinAn Street, BaoAn District, Shenzhen, Guangdong. P.R.China.	
Product	Rechargeable Li-ion Battery	
Brand Name	AMASSTORE	
Model	GTX5000	
Additional Model & Model Difference	N/A	
Date of tests	Jan. 09, 2020 ~ Apr. 10, 2020	

The submitted sample of the above equipment has been tested according to the requirements of the following standards:

- EN 61000-6-3:2007 + A1:2011 + AC:2012
- EN 61000-6-2:2005

CONCLUSION: The submitted sample was found to COMPLY with the test requirement

Tested by Ryan Lu Project Engineer / EMC Department	Approved by Madison Luo Assistant Manager / EMC Department
	 Date: Jul. 03, 2020

This report is governed by, and incorporates by reference, CPS Conditions of Service as posted at the date of issuance of this report at <http://www.bureauveritas.com/home/about-us/our-business/cps/about-us/terms-conditions> and is intended for your exclusive use. Any copying or replication of this report to or for any other person or entity, or use of our name or trademark, is permitted only with our prior written permission. This report sets forth our findings solely with respect to the test samples identified herein. The results set forth in this report are not indicative or representative of the quality or characteristics of the lot from which a test sample was taken or any similar or identical product unless specifically and expressly noted. Our report includes all of the tests requested by you and the results thereof based upon the information that you provided to us. Measurement uncertainty is only provided upon request for accredited tests. You have 60 days from date of issuance of this report to notify us of any material error or omission caused by our negligence or if you require measurement uncertainty; provided, however, that such notice shall be in writing and shall specifically address the issue you wish to raise. A failure to raise such issue within the prescribed time shall constitute you unqualified acceptance of the completeness of this report, the tests conducted and the correctness of the report contents.

Bureau Veritas Shenzhen Co., Ltd.
Dongguan Branch

No. 96, Guantai Road (Houjie Section), Houjie Town, Dongguan City, Guangdong Province. 523942. People's Republic of China.

Tel: +86 769 8998 2098
Fax: +86 769 8593 1080
Email: customerservice.dg@cn.bureauveritas.com



Table of Contents

RELEASE CONTROL RECORD 4

1 SUMMARY OF TEST RESULTS 5

1.1 MEASUREMENT UNCERTAINTY 6

2 GENERAL INFORMATION 7

2.1 GENERAL DESCRIPTION OF EUT 7

2.2 DESCRIPTION OF TEST MODES 8

2.3 GENERAL DESCRIPTION OF APPLIED STANDARDS 9

2.4 DESCRIPTION OF SUPPORT UNITS 9

3 EMISSION TEST 10

3.1 RADIATED EMISSION MEASUREMENT 10

3.1.1 LIMITS OF RADIATED EMISSION MEASUREMENT 10

3.1.2 TEST INSTRUMENTS 11

3.1.3 TEST PROCEDURE 12

3.1.4 DEVIATION FROM TEST STANDARD 13

3.1.5 TEST SETUP 14

3.1.6 EUT OPERATING CONDITIONS 14

3.1.7 TEST RESULTS 15

4 IMMUNITY TEST 17

4.1 GENERAL DESCRIPTION 17

4.1.1 GENERAL DESCRIPTION OF EN 61000-6-2 17

4.1.2 PERFORMANCE CRITERIA 18

4.1.3 EUT OPERATING CONDITION 18

4.2 ELECTROSTATIC DISCHARGE IMMUNITY TEST (ESD) 19

4.2.1 TEST SPECIFICATION 19

4.2.2 TEST INSTRUMENTS 19

4.2.3 TEST PROCEDURE 20

4.2.4 DEVIATION FROM TEST STANDARD 20

4.2.5 TEST SETUP 21

4.2.6 TEST RESULTS 22

4.3 RADIATED, RADIO-FREQUENCY, ELECTROMAGNETIC FIELD 24

IMMUNITY TEST (RS) 24

4.3.1 TEST SPECIFICATION 24

4.3.2 TEST INSTRUMENTS 24

4.3.3 TEST PROCEDURE 25

4.3.4 DEVIATION FROM TEST STANDARD 25

4.3.5 TEST SETUP 25

4.3.6 TEST RESULTS 26

4.4 ELECTRICAL FAST TRANSIENT/BURST IMMUNITY TEST (EFT) 27

4.4.1 TEST SPECIFICATION 27

4.4.2 TEST INSTRUMENTS 27

4.4.3 TEST PROCEDURE 27

4.4.4 DEVIATION FROM TEST STANDARD 27

4.4.5 TEST SETUP 28



4.4.6	TEST RESULTS	29
4.5	IMMUNITY TO CONDUCTED DISTURBANCES INDUCED BY RF	30
	FIELDS (CS).....	30
4.6.1	TEST SPECIFICATION	30
4.6.2	TEST INSTRUMENTS.....	30
4.6.3	TEST PROCEDURE.....	31
4.6.4	DEVIATION FROM TEST STANDARD.....	31
4.6.5	TEST SETUP.....	32
4.6.6	TEST RESULTS	33
4.6	POWER FREQUENCY MAGNETIC FIELD IMMUNITY TEST	34
4.6.1	TEST SPECIFICATION	34
4.6.2	TEST INSTRUMENTS.....	34
4.6.3	TEST PROCEDURE.....	34
4.6.4	DEVIATION FROM TEST STANDARD.....	34
4.6.5	TEST SETUP.....	35
4.6.6	TEST RESULTS	36
5	PHOTOGRAPHS OF THE TEST CONFIGURATION	37
6	APPENDIX A – MODIFICATIONS RECORDERS FOR ENGINEERING CHANGES TO THE EUT BY THE LAB	41



BUREAU
VERITAS

Test Report No.: CE200109N021-2

RELEASE CONTROL RECORD

ISSUE NO.	REASON FOR CHANGE	DATE ISSUED
CE200109N021-2	Original release	Jul. 03, 2020

Bureau Veritas Shenzhen Co., Ltd.
Dongguan Branch

No. 96, Guantai Road (Houjie Section),
Houjie Town, Dongguan City, Guangdong
Province. 523942. People's Republic of
China.

Tel: +86 769 8998 2098
Fax: +86 769 8593 1080
Email: customerservice.dg@cn.bureauveritas.com



1 SUMMARY OF TEST RESULTS

The EUT has been tested according to the following specifications:

EMISSION			
Standard	Test Type	Result	Remarks
EN 61000-6-3:2007+ A1:2011+AC:2012	Radiated test (30MHz~1GHz)	PASS	Meets limits minimum passing margin is -8.52dB at 42.731MHz

IMMUNITY (EN 61000-6-2:2005)			
Standard	Test Type	Result	Remarks
IEC 61000-4-2:2008 ED. 2.0	Electrostatic discharge immunity test	PASS	Electrostatic Discharge – ESD: 8kV Air discharge, 4kV Contact discharge, Performance Criterion A
IEC 61000-4-3:2010 ED. 3.2	Radiated, radio-frequency, electromagnetic field immunity test	PASS	Radio-Frequency Electromagnetic Field Susceptibility Test – RS: 80-1000 MHz, 10V/m, 80% AM (1kHz), 1400-2000 MHz, 3V/m, 80% AM (1kHz) 2000-2700 MHz, 1V/m, 80% AM (1kHz) Performance Criterion A
IEC 61000-4-4:2012 ED. 3.0	Electrical fast transient / burst immunity test.	PASS	Electrical Fast Transient/Burst - EFT AC Power line: 2kV, DC Power line 2kV, Performance Criterion A
IEC 61000-4-6:2013 ED. 4.0	Immunity to conducted disturbances, induced by radio-frequency fields	PASS	Conducted Radio Frequency Disturbances Test – CS: 0.15-80 MHz, 10Vrms, 80% AM, 1kHz, Performance Criterion A
IEC 61000-4-8:2009 ED. 2.0	Power frequency magnetic field immunity test.	PASS	Power Frequency Magnetic Field Test, 50 Hz, 30A/m, Performance Criterion A



1.1 MEASUREMENT UNCERTAINTY

Where relevant, the following measurement uncertainty levels have been estimated for tests performed on the EUT as specified in CISPR 16-4-2:

This uncertainty represents an expanded uncertainty expressed at approximately the 95% confidence level using a coverage factor of $k=2$.

MEASUREMENT	FREQUENCY	UNCERTAINTY
Radiated Disturbance Test	30MHz ~ 1000MHz	+ /-3.99 dB



2 GENERAL INFORMATION

2.1 GENERAL DESCRIPTION OF EUT

PRODUCT	Rechargeable Li-ion Battery
MODEL NO.	GTX5000
ADDITIONAL MODELS	N/A
POWER SUPPLY	DC 51.2V, 100Ah, 5120Wh from Battery Charging: DC 56.16V 50A Max Discharging: DC 51.2V 75A Max
THE HIGHEST OPERATING FREQUENCY	Below 108MHz
DATA CABLE SUPPLIED	N/A

NOTE:

1. For the test results, the EUT had been tested with all conditions. But only the worst case was showed in test report.
2. For a more detailed features description, please refer to the manufacturer's specifications or the User's Manual.
3. Please refer to the EUT photo document (Reference No.: 200109N021) for detailed product photo.



2.2 DESCRIPTION OF TEST MODES

The EUT was tested under the following modes' the final worst mode was marked in boldface and recorded in this report.

◆ FOR RADIATED EMISSION TEST

Description of Test Mode	Test Voltage
Charging	DC 56.16V from PV inverter
Discharging	DC 51.2V from Battery

◆ FOR IMMUNITY TESTS

Description of Test Mode	Test Voltage
Charging	DC 56.16V from PV inverter
Discharging	DC 51.2V from Battery



2.3 GENERAL DESCRIPTION OF APPLIED STANDARDS

The EUT has been tested and complied with the requirements of the following standards:

EN 61000-6-3:2007 + A1:2011 + AC:2012

EN 61000-6-2:2005

IEC 61000-4-2:2008 ED. 2.0

IEC 61000-4-3:2010 ED. 3.2

IEC 61000-4-4:2012 ED. 3.0

IEC 61000-4-6:2013 ED. 4.0

IEC 61000-4-8:2009 ED. 2.0

Notes: The above IEC basic standards are applied with latest version if customer has no special requirement.

2.4 DESCRIPTION OF SUPPORT UNITS

The EUT has been tested as an dependent unit together with other necessary accessories or support units. The following support units or accessories were used to form a representative test configuration during the tests.

NO.	PRODUCT	BRAND	MODEL NO.	SERIAL NO.	FCC ID
1	PV inverter	Sofar	HYD 20000TL-3PH	N/A	N/A

NO.	CABLE DESCRIPTION OF THE ABOVE SUPPORT UNITS
1	DC Line: Unshielded, Detachable 10.0m



3 EMISSION TEST

3.1 RADIATED EMISSION MEASUREMENT

3.1.1 LIMITS OF RADIATED EMISSION MEASUREMENT

TEST STANDARD: EN 61000-6-3

FREQUENCY RANGE OF RADIATED MEASUREMENT
(For unintentional radiators)

Highest frequency generated or Upper frequency of measurement used in the device or on which the device operates or tunes (MHz)	Range (MHz)
Below 108	1000
108 – 500	2000
500 – 1000	5000
Above 1000	Up to 5 times of the highest frequency or 6 GHz, whichever is less

FOR FREQUENCY BELOW 1000 MHz

FREQUENCY (MHz)	3m	10m
	Quasi-Peak (dBuV/m)	Quasi-Peak (dBuV/m)
30 – 230	40	30
230 – 1000	47	37

FOR FREQUENCY ABOVE 1000 MHz

FREQUENCY (GHz)	3m	
	PEAK(dBuV/m)	AVERAGE(dBuV/m)
1 to 3	70	50
3 to 6	74	54

NOTE: (1) The lower limit shall apply at the transition frequencies.
(2) Emission level (dBuV/m) = 20 log Emission level (uV/m).



3.1.2 TEST INSTRUMENTS

FOR FREQUENCY BELOW 1GHz

Equipment	Manufacturer	Model No.	Serial No.	Last Cal.	Next Cal.
EMI Test Receiver	Rohde&Schwarz	ESU26	100005	May 20,19	May 19, 20
EMI Test Receiver	Rohde&Schwarz	ESR7	101564	Mar. 12,20	Mar. 11, 21
Trilog-Broadband Antenna	SCHWARZBECK	VULB 9168	9168-555	Nov. 24, 19	Nov. 23, 20
Trilog-Broadband Antenna	SCHWARZBECK	VULB 9168	9168-554	Dec. 01, 19	Nov. 30, 20
Preamplifier	EMCI	EMC1135	980378	Mar. 15,20	Mar. 14,21
Preamplifier	EMCI	EMC1135	980423	Mar. 15,20	Mar. 14,21
10m Semi-anechoic Chamber	CHANGLING	21.4m*12.1m*8.8m	NSEMC006	Apr. 20,19	Apr. 19,20
Test Software	ADT	ADT_Radiated_V8.7.07	N/A	N/A	N/A

- NOTES:** 1. The test was performed in 10m Chamber.
2. The calibration interval of the above test instruments is 12 months. And the calibrations are traceable to CEPREI/CHINA, GRGT/CHINA and NIM/CHINA.

FREQUENCY RANGE ABOVE 1GHz

Equipment	Manufacturer	Model No.	Serial No.	Last Cal.	Next Cal.
Horn Antenna	ETS-Lindgren	3117	00085519	Nov. 24, 19	Nov. 23, 20
Horn Antenna	SCHWARZBECK	BBHA 9170	BBHA9170147	Jun. 23,19	Jun. 22,20
Signal and Spectrum Analyzer	Rohde&Schwarz	FSV40	101003	Mar. 12,20	Mar. 11,21
Broadband Preamplifier (1~18GHz)	SCHWARZBECK	BBV9718	266	Apr. 21,19	Apr. 20,20
Pre-Amplifier (18GHz-40GHz)	EMCI	EMC 184045	980102	Nov. 09,19	Nov. 08,20
Test Software	ADT	ADT_Radiated_V8.7.07	N/A	N/A	N/A

- NOTES:** 1. The test was performed in 10m Chamber.
2. The calibration interval of the above test instruments are 12 months. And the calibrations are traceable to CEPREI/CHINA, GRGT/CHINA and NIM/CHINA.



3.1.3 TEST PROCEDURE

<Frequency Range below 1GHz>

- a. The EUT was placed on the top of a rotating table 0.8 meters above the ground at a 10 meter chamber room. The table was rotated 360 degrees to determine the position of the highest radiation.
- b. The EUT was set 10 meters away from the interference-receiving antenna, which was mounted on the top of a variable-height antenna tower.
- c. The height of antenna is varied from one meter to four meters above the ground to determine the maximum value of the field strength. Both horizontal and vertical polarizations of the antenna are set to make the measurement.
- d. For each suspected emission, the EUT was arranged to its worst case and then the antenna was tuned to heights from 1 meter to 4 meters and the turn table was turned from 0 degrees to 360 degrees to find the maximum reading.
- e. The test-receiver system was set to quasi-peak detect function and specified bandwidth with maximum hold mode when the test frequency is below 1 GHz.

NOTE:

1. The resolution bandwidth of test receiver/spectrum analyzer is 120kHz for Quasi-peak detection (QP) at frequency below 1GHz.
2. Emission level(dBuV/m)=Raw Value(dBuV) + Correction Factor(dB/m)
3. Correction Factor(dB/m) = Antenna Factor (dB/m) + Cable Factor (dB) (if the raw value not contains the amplifier);
4. Correction Factor(dB/m) = Antenna Factor (dB/m) + Cable Factor (dB) – Amplifier Gain(dB) (if the raw value contains the amplifier).
5. Margin value = Emission level – Limit value.



<Frequency Range above 1GHz>

- a. The EUT was placed on the top of a rotating table 0.8 meters above the ground at a 10 meter Semi-anechoic chamber room. The table was rotated 360 degrees to determine the position of the highest radiation.
- b. The EUT was set 3 meters away from the interference-receiving antenna, which was mounted on the top of a variable-height antenna tower.
- c. The height of antenna can be varied from one meter-to four meters, the height of adjustment depends on the EUT height and the antenna 3dB beamwidth both, to detect the maximum value of the field strength. Both horizontal and vertical polarizations of the antenna are set to make the measurement. The bore sight should be used during the test above 1GHz.
- d. For each suspected emission, the EUT was arranged to its worst case and then the antenna was tuned to heights and the rotatable table was turned from 0 degrees to 360 degrees to find the maximum reading.
- e. The test receiver/spectrum was set to peak and average detect function and specified bandwidth with maximum hold mode when the test frequency is above 1 GHz.

NOTE:

1. The resolution bandwidth is 1MHz and video bandwidth of test receiver/spectrum analyzer is 3MHz for Peak detection at frequency above 1GHz. The resolution bandwidth of test receiver/spectrum analyzer is 1 MHz for Average detection (AV) at frequency above 1GHz.
2. For measurement of frequency above 1000 MHz, the EUT was set 3 meters away from the receiver antenna.
3. Emission level(dBuV/m)=Raw Value(dBuV) + Correction Factor(dB/m)
4. Correction Factor (dB/m) = Antenna Factor (dB/m) + Cable Factor (dB) (if the raw value not contains the amplifier).
5. Correction Factor (dB/m) = Antenna Factor (dB/m) + Cable Factor (dB) – Amplifier Gain (dB) (if the raw value contains the amplifier).
6. Margin value = Emission level – Limit value.

3.1.4 DEVIATION FROM TEST STANDARD

No deviation



3.1.5 TEST SETUP

<Frequency Range below 1GHz>

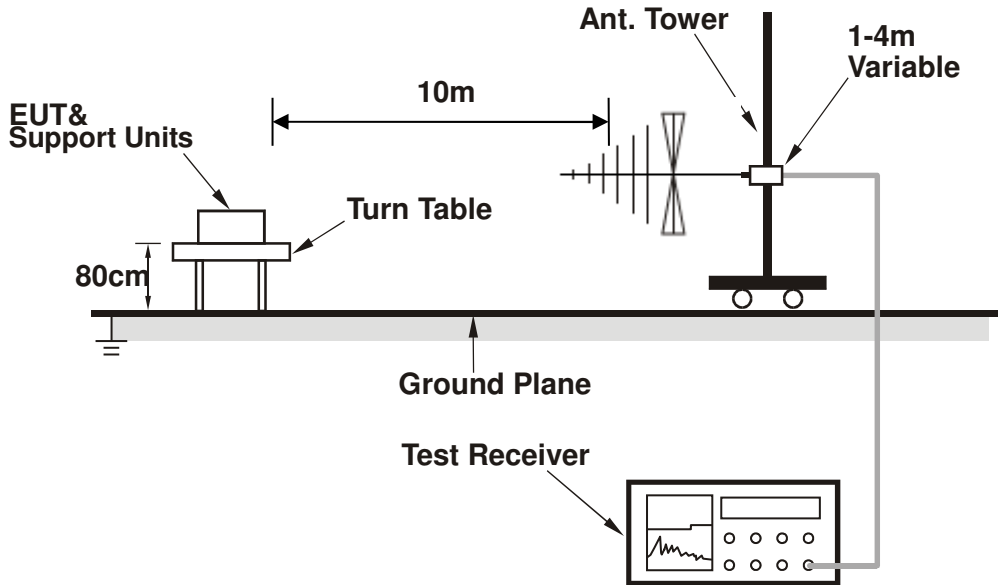

<Frequency Range above 1GHz>

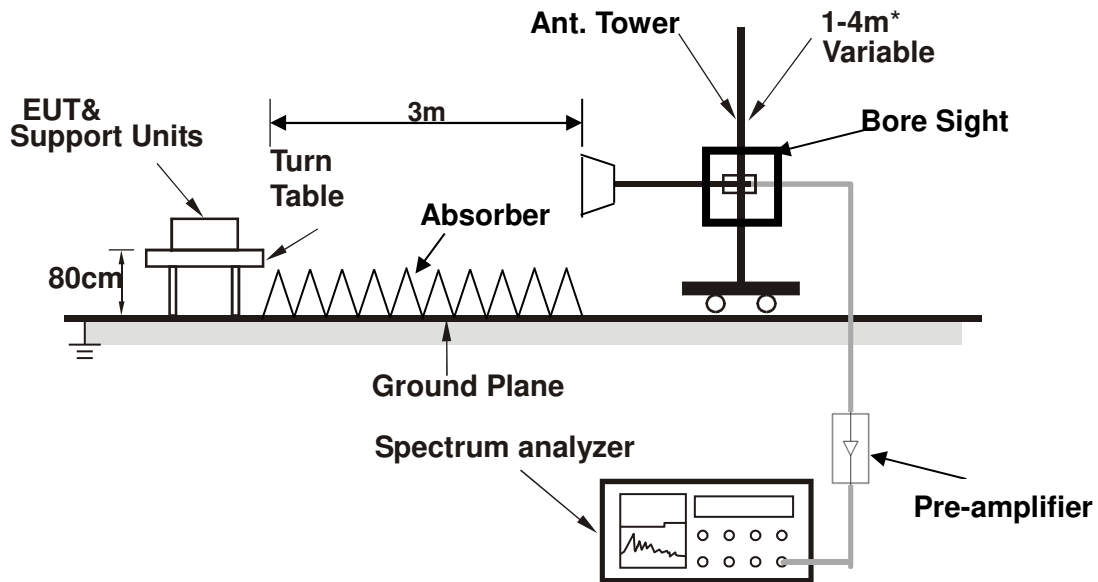

* :depends on the EUT height and the antenna 3dB beamwidth both, refer to section 7.3 of CISPR 16-2-3.

3.1.6 EUT OPERATING CONDITIONS

Same as item 3.1.6



3.1.7 TEST RESULTS

TEST MODE	Charging	FREQUENCY RANGE	30-1000 MHz
TEST VOLTAGE	DC 56.16V from PV inverter	DETECTOR FUNCTION & BANDWIDTH	Quasi-Peak, 120kHz
ENVIRONMENTAL CONDITIONS	24 deg. C, 55% RH	TESTED BY: Kamiko	

ANTENNA POLARITY & TEST DISTANCE: HORIZONTAL AT 10 M								
No.	Freq. (MHz)	Correction Factor (dB/m)	Raw Value (dBuV)	Emission Level (dBuV/m)	Limit (dBuV/m)	Margin (dB)	Antenna Height (cm)	Table Angle (Degree)
1	42.731	-21.04	42.52	21.48	30.00	-8.52	400	23
2	127.970	-19.53	34.25	14.72	30.00	-15.28	400	303
3	173.439	-17.32	30.03	12.71	30.00	-17.29	400	260
4	354.586	-13.55	29.80	16.25	37.00	-20.75	200	60
5	405.269	-11.73	30.98	19.25	37.00	-17.75	400	72
6	579.020	-7.56	29.64	22.08	37.00	-14.92	400	23

- REMARKS:**
1. Peak detector quick scan is showed on the graph and final quasi-peak detector data is measured corresponding to relevant limit and recorded in the data table.
 2. Negative sign (-) in the margin column signify levels below the limit.
 3. Frequency range scanned: 30MHz to 1000MHz.
 4. Only emissions significantly above equipment noise floor are reported

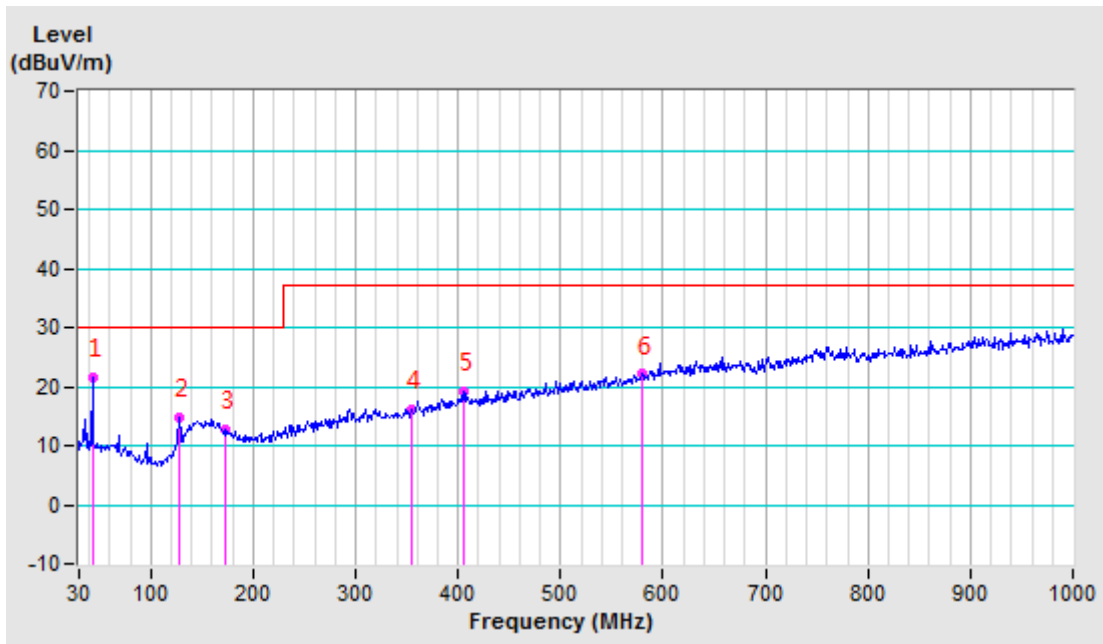



TEST MODE	Charging	FREQUENCY RANGE	30-1000 MHz
TEST VOLTAGE	DC 56.16V from PV inverter	DETECTOR FUNCTION & BANDWIDTH	Quasi-Peak, 120kHz
ENVIRONMENTAL CONDITIONS	24 deg. C, 55% RH	TESTED BY: Kamiko	

ANTENNA POLARITY & TEST DISTANCE: VERTICAL AT 10 M								
No.	Freq. (MHz)	Correction Factor (dB/m)	Raw Value (dBuV)	Emission Level (dBuV/m)	Limit (dBuV/m)	Margin (dB)	Antenna Height (cm)	Table Angle (Degree)
1	33.444	-18.19	38.87	20.68	30.00	-9.32	300	144
2	96.012	-20.61	35.73	15.12	30.00	-14.88	300	337
3	127.975	-17.56	37.48	19.92	30.00	-10.08	100	344
4	244.429	-17.20	30.43	13.23	37.00	-23.77	300	337
5	368.935	-12.69	29.96	17.27	37.00	-19.73	300	337
6	492.616	-9.88	28.96	19.08	37.00	-17.92	300	339

- REMARKS:**
1. Peak detector quick scan is showed on the graph and final quasi-peak detector data is measured corresponding to relevant limit and recorded in the data table.
 2. Negative sign (-) in the margin column signify levels below the limit.
 3. Frequency range scanned: 30MHz to 1000MHz.
 4. Only emissions significantly above equipment noise floor are reported

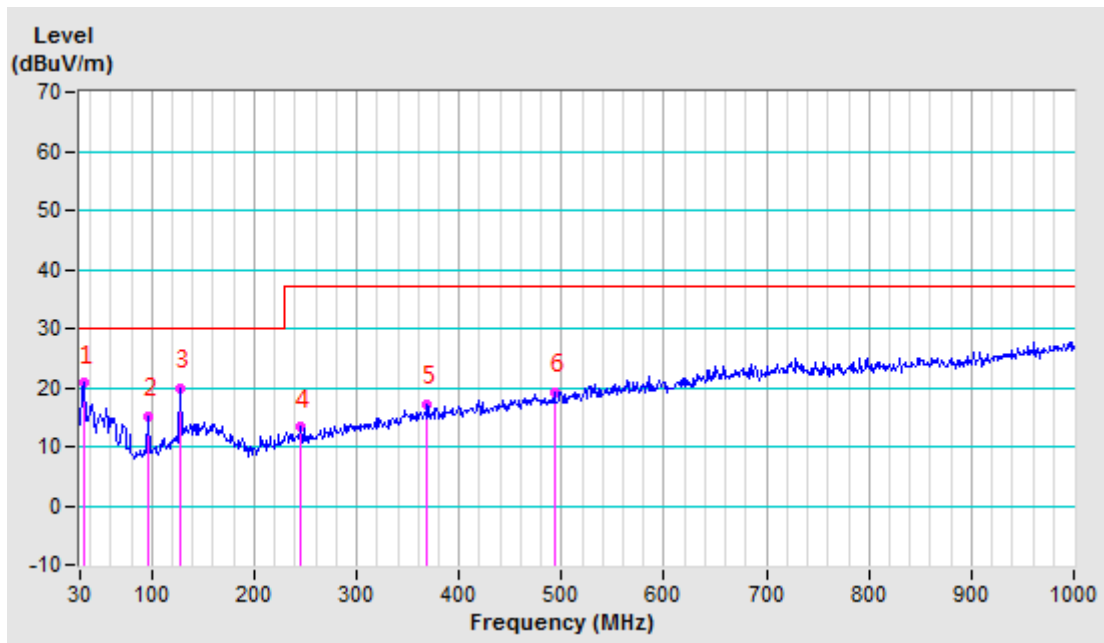



4 IMMUNITY TEST

4.1 GENERAL DESCRIPTION

4.1.1 GENERAL DESCRIPTION OF EN 61000-6-2

Product Standard:	EN 61000-6-2:2005	
Basic Standard, specification requirement, and Performance Criteria:	IEC 61000-4-2	Electrostatic Discharge – ESD: 4kV Contact discharge, 8kV air discharge, Performance Criterion B
	IEC 61000-4-3	Radio-Frequency Electromagnetic Field Susceptibility Test – RS: 80-1000 MHz, 10V/m, 80% AM (1kHz), 1400-2000 MHz, 3V/m, 80% AM (1kHz) 2000-2700 MHz, 1V/m, 80% AM (1kHz) Performance Criterion A
	IEC 61000-4-4	Electrical Fast Transient/Burst - EFT AC Power line: 2kV, DC Power line: 2kV Signal line: 1kV Performance Criterion B
	IEC 61000-4-6	Conducted Radio Frequency Disturbances Test – CS: 0.15-80 MHz, 10Vrms, 80% AM, 1kHz, Performance Criterion A
	IEC 61000-4-8	Power Frequency Magnetic Field Test, 50 Hz, 30A/m, Performance Criterion A



4.1.2 PERFORMANCE CRITERIA

According to Clause 4 of EN 61000-6-2:2005 standard, the following describes the general performance criteria.

CRITERION A	The apparatus shall continue to operate as intended during and after the test. No degradation of performance or loss of function is allowed below a performance level specified by the manufacturer, when the apparatus is used as intended. The performance level may be replaced by a permissible loss of performance. If the minimum performance level or the permissible performance loss is not specified by the manufacturer, either of these may be derived from the product description and documentation and what the user may reasonably expect from the apparatus if used as intended.
CRITERION B	The apparatus shall continue to operate as intended after the test. No degradation of performance or loss of function is allowed below a performance level specified by the manufacturer, when the apparatus is used as intended. The performance level may be replaced by a permissible loss of performance. During the test, degradation of performance is however allowed. No change of actual operating state or stored data is allowed. If the minimum performance level or the permissible performance loss is not specified by the manufacturer, either of these may be derived from the product description and documentation and what the user may reasonably expect from the apparatus if used as intended.
CRITERION C	Temporary loss of function is allowed, provided the function is self-recoverable or can be restored by the operation of the controls.

4.1.3 EUT OPERATING CONDITION

Same as item 3.1.6



4.2 ELECTROSTATIC DISCHARGE IMMUNITY TEST (ESD)

4.2.1 TEST SPECIFICATION

Basic Standard:	IEC 61000-4-2
Discharge Impedance:	330 ohm / 150 pF
Discharge Voltage:	Air Discharge: 8 kV (Direct) Contact Discharge: 4 kV (Indirect)
Polarity:	Positive & Negative
Number of Discharge:	20 times at each test point
Discharge Mode:	Single Discharge
Discharge Period:	1 second

4.2.2 TEST INSTRUMENTS

Equipment	Manufacturer	Model No.	Serial No.	Last Cal.	Next Cal.
ESD Generator	TESEQ	NSG 437	279	Mar. 13,20	Mar. 12,21
Test Software	TESEQ	V03.03	N/A	N/A	N/A
ESD Generator	EM TEST	Dito	V1211112265	Nov. 30,19	Nov. 29,20
Test Software	EM TEST	V 2.31	N/A	N/A	N/A

- NOTES:**
1. The test was performed in ESD Room.
 2. The calibration interval of the above test instruments is 12 months and the calibrations are traceable to CEPREI/CHINA, GRGT/CHINA and NIM/CHINA.



4.2.3 TEST PROCEDURE

The basic test procedure was in accordance with IEC 61000-4-2:

- a. Electrostatic discharges were applied only to those points and surfaces of the EUT that are accessible to users during normal operation.
- b. The test was performed with at least ten single discharges on the pre-selected points in the most sensitive polarity.
- c. The time interval between two successive single discharges was at least 1 second.
- d. The discharge return cable of the generator shall be kept at a distance of at least 0.2 m from the EUT whilst the discharge is being applied and should not be held by the operator.
- e. Contact discharges were applied to the non-insulating coating, with the pointed tip of the generator penetrating the coating and contacting the conducting substrate.
- f. Air discharges were applied with the round discharge tip of the discharge electrode approaching the EUT as fast as possible (without causing mechanical damage) to touch the EUT. After each discharge, the ESD generator was removed from the EUT and re-triggered for a new single discharge. The test was repeated until all discharges were complete.
- g. At least ten single discharges (in the most sensitive polarity) were applied to the **Horizontal Coupling Plane** at points on each side of the EUT. The ESD generator was positioned horizontal at a distance of 0.1 meters from the EUT with the discharge electrode touching the **HCP**.
- h. At least ten single discharges (in the most sensitive polarity) were applied to the center of one vertical edge of the **Vertical Coupling Plane** in sufficiently different positions that the four faces of the EUT were completely illuminated. The **VCP** (dimensions 0.5m x 0.5m) was placed vertically to and 0.1 meters from the EUT.

4.2.4 DEVIATION FROM TEST STANDARD

No Deviation



4.2.5 TEST SETUP

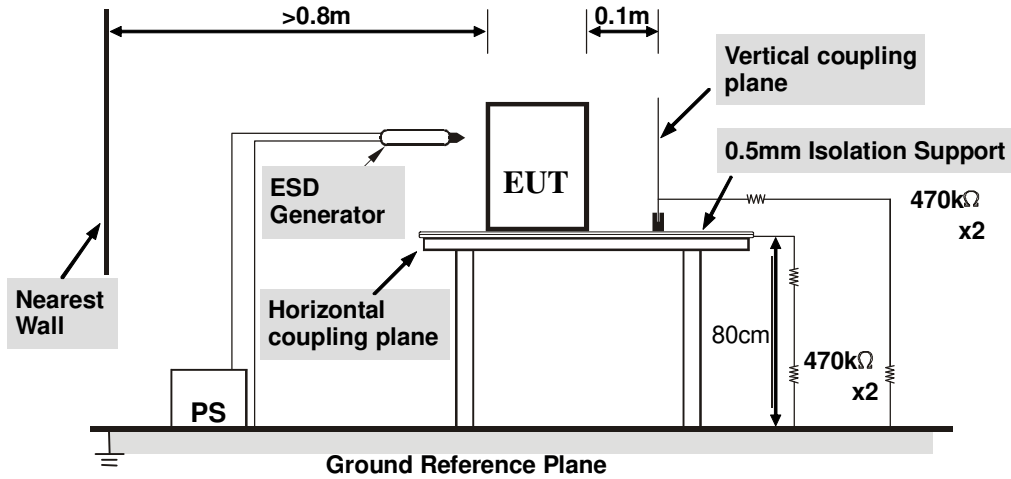

NOTE:

TABLE-TOP EQUIPMENT

The configuration consisted of a wooden table 0.8 meters high standing on the **Ground Reference Plane**. The **GRP** consisted of a sheet of aluminum at least 0.25mm thick, and 2.5 meters square connected to the protective grounding system. A **Horizontal Coupling Plane** (1.6m x 0.8m) was placed on the table and attached to the **GRP** by means of a cable with 940kΩ total impedance. The equipment under test, was installed in a representative system as described in section 7 of IEC 61000-4-2, and its cables were placed on the **HCP** and isolated by an insulating support of 0.5mm thickness. A distance of 0.8-meter minimum was provided between the EUT and the walls of the laboratory and any other metallic structure.

FLOOR-STANDING EQUIPMENT

The equipment under test was installed in a representative system as described in section 7 of IEC 61000-4-2, and its cables were isolated from the Ground Reference Plane by an insulating support of 0.1-meter thickness. The GRP consisted of a sheet of aluminum that is at least 0.25mm thick, and 2.5 meters square connected to the protective grounding system and extended at least 0.5 meters from the EUT on all sides.



4.2.6 TEST RESULTS

TEST MODE	See section 2.2	TEST VOLTAGE	See section 2.2
ENVIRONMENTAL CONDITIONS	24.1eg. C, 47.2% RH, 101.5KPA	TESTED BY: Dragon	

Direct Discharge Application				
Test Level (kV)	Polarity	Test Point	Test Result of Contact Discharge	Test Result of Air Discharge
4	+/-	All Metal Part	A	N/A
8	+/-	All Non-metal Part	N/A	A

Indirect Discharge Application				
Discharge Level (kV)	Polarity	Test Point	Test Result of HCP	Test Result of VCP
4	+/-	HCP	A	N/A
4	+/-	VCP	N/A	A

NOTE: A: There was no change compared with initial operation during the test.



**BUREAU
VERITAS**

Test Report No.: CE200109N021-2

ESD TEST POINT

(○ - Direct Contact Discharge; ✦ - Air Discharge)





4.3 RADIATED, RADIO-FREQUENCY, ELECTROMAGNETIC FIELD IMMUNITY TEST (RS)

4.3.1 TEST SPECIFICATION

Basic Standard:	IEC 61000-4-3
Frequency Range:	80-1000MHz, 1400-2000MHz, 2000-2700MHz
Field Strength:	10V/m, 3V/m, 1V/m
Modulation:	1kHz Sine Wave, 80%, AM Modulation
Frequency Step:	1 % of fundamental
Polarity of Antenna:	Horizontal and Vertical
Antenna Height:	1.5m
Dwell Time:	at least 3 seconds

4.3.2 TEST INSTRUMENTS

Equipment	Manufacturer	Model No.	Serial No.	Last Cal.	Next Cal.
Signal Generator	Agilent	N5181A	MY50142530	Sep. 12,19	Sep. 11,20
Antenna Log-Periodic	AR	ATR80M6G	0337307	N/A	N/A
Antenna Log-Periodic	AR	ATS700M11G	0336821	N/A	N/A
Switch Controller	AR	SC1000	0337343	N/A	N/A
RF Power Meter	ESE	4242	13984	Sep. 12,19	Sep. 11,20
Power Sensor	ESE	51011EMC	35716	Sep. 12,19	Sep. 11,20
Power Sensor	ESE	51011EMC	35715	Sep. 12,19	Sep. 11,20
E-Field probe	Narda	NBM-520	2403/01B	Sep. 25,19	Sep. 24,20
Power Amplifier	TESEQ	CBA 1G-150	T44029	N/A	N/A
Power Amplifier	TESEQ	CBA 3G-100	T44030	N/A	N/A
Power Amplifier	TESEQ	CBA 6G-050	1041204	N/A	N/A
Dual Directional Coupler	TESEQ	C5982	95208	Sep. 21,19	Sep. 20,20
Dual Directional Coupler	TESEQ	C6187	95175	Sep. 21,19	Sep. 20,20
Dual Directional Coupler	TESEQ	CPH-274F	M251304-01	Sep. 21,19	Sep. 20,20
Test Software	Tonscend	TS+	2.5.0.0	N/A	N/A
Test Software	ADT	BVADT_RS_V7 .6.4-DG	N/A	N/A	N/A
Audio analyzer	Rohde&Schwarz	UPV	101346	Jun. 13,19	Jun. 12,20
EAR SIMULATOR	B&K	4192	2764719	Aug. 10,19	Aug.09,20
Sound Calibrator	B&K	Type 4231	2463874	Jul. 25,19	Jul.24,20
Conditioning Amplifier	B&K	2690A0S2	2437856	Sep. 10,19	Sep.09,20
Universal Radio Communication Tester	Rohde&Schwarz	CMU 200	119669	Mar. 12,20	Mar. 11,21

- NOTES:** 1. The test was performed in RS chamber.
 2. The calibration interval of the above test instruments is 12 months and the calibrations are traceable to CEPREI/CHINA, GRGT/CHINA and NIM/CHINA.



4.3.3 TEST PROCEDURE

The test procedure was in accordance with IEC 61000-4-3

- a. The testing was performed in a fully-anechoic chamber.
- b. The frequency range is swept from 80 MHz to 1000 MHz, 1400MHz to 2000MHz, 2000MHz to 2700MHz with the signal 80% amplitude modulated with a 1kHz sine wave.
- c. The dwell time at each frequency shall not be less than the time necessary for the EUT to be exercised and to respond, but shall in no case be less than 0,5s.
- d. The field strength levels were 10V/m, 3V/m, 1V/m
- e. The test was performed with the EUT exposed to both vertically and horizontally polarized fields on each of the four sides.

4.3.4 DEVIATION FROM TEST STANDARD

No Deviation

4.3.5 TEST SETUP

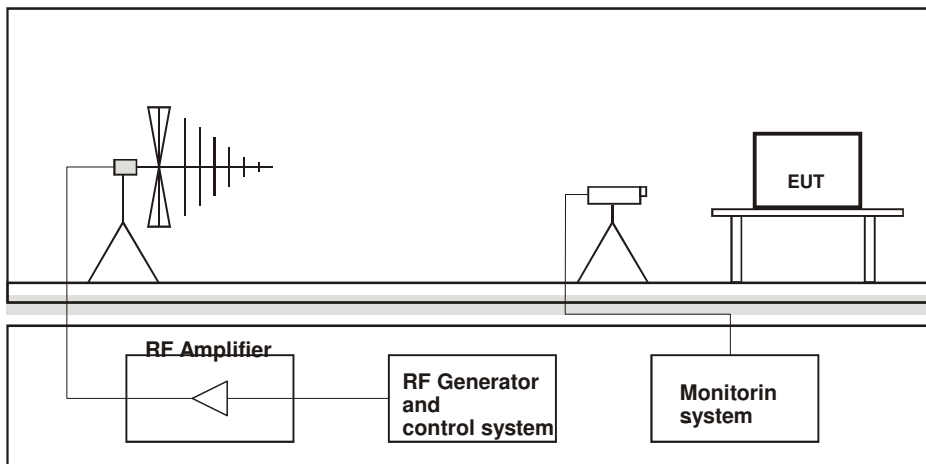

NOTE:

TABLETOP EQUIPMENT

The EUT installed in a representative system as described in section 7 of IEC 61000-4-3 was placed on a non-conductive table 0.8 meters in height. The system under test was connected to the power and signal wire according to relevant installation instructions.

FLOOR STANDING EQUIPMENT

The EUT installed in a representative system as described in section 7 of IEC 61000-4-3 was placed on a non-conductive wood support 0.1 meters in height. The system under test was connected to the power and signal wire according to relevant installation instructions.



4.3.6 TEST RESULTS

TEST MODE	See section 2.2	TEST VOLTAGE	See section 2.2
ENVIRONMENTAL CONDITIONS	22.8deg.C, 57.6% RH	TESTED BY: Dragon	

Field Strength (V/m)	Test Frequency Note#1 (MHz)	Polarization of antenna (Horizontal / Vertical)	Test Distance (m)	Test Result	Remark
10	80 - 1000	H&V	3	A	N/A
3	1400 - 2000	H&V	3	A	N/A
1	2000 - 2700	H&V	3	A	N/A

Note#1:

Tested Israel SII Frequencies 89,100,107,144,163,196,244,315,434,460,600,825,845,880 MHz

NOTE: A: There was no change compared with initial operation during the test.



4.4 ELECTRICAL FAST TRANSIENT/BURST IMMUNITY TEST (EFT)

4.4.1 TEST SPECIFICATION

Basic Standard:	IEC 61000-4-4
Test Voltage:	Power Line: 2kV
Polarity:	Positive & Negative
Impulse Frequency:	5 kHz
Impulse Waveshape :	5/50 ns
Burst Duration:	15 ms
Burst Period:	300 ms
Test Duration:	1 min.

4.4.2 TEST INSTRUMENTS

Equipment	Manufacturer	Model No.	Serial No.	Last Cal.	Next Cal.
Combination wave Module	TESEQ	CDN 3061	1361	Mar. 13,20	Mar. 12,21
Telecom Surge Module	TESEQ	NSG 3060 Mainframe	1404	Mar. 13,20	Mar. 12,21
Automated 3- Phase Coupling/ Decoupling Network	TESEQ	CDN 3063	2131	Mar. 13,20	Mar. 12,21
CDN	TESEQ	CDN HSS-2	34275	Mar. 13,20	Mar. 12,21
CDN	TESEQ	CDN 118	30741	Mar. 13,20	Mar. 12,21
Test Software	TESEQ	CDM 3061_0002.30	1361	N/A	N/A
Test Software	TESEQ	HVM 3060_0002.30	293	N/A	N/A
EFT Tester	HAEFELY	PEFT4010	150546	Mar. 13,20	Mar. 12,21
EFT Coupling Clamp	HAEFELY	IP4A	150407	Mar. 13,20	Mar. 12,21
Test Software	HAEFELY	SWPE4010 1.22	N/A	N/A	N/A

- NOTES:** 1. The test was performed in EMS Room.
 2. The calibration interval of the above test instruments is 12 months and the calibrations are traceable to CEPREI/CHINA, GRGT/CHINA and NIM/CHINA.

4.4.3 TEST PROCEDURE

- Both positive and negative polarity discharges were applied.
- The length of the “hot wire” from the coaxial output of the EFT generator to the terminals on the EUT should not exceed 0.5 meter ± 0.05 meter.
- The duration time of each test sequential was 1 minute.
- The transient/burst waveform was in accordance with IEC 61000-4-4, 5/50ns.

4.4.4 DEVIATION FROM TEST STANDARD

No deviation.



4.4.5 TEST SETUP

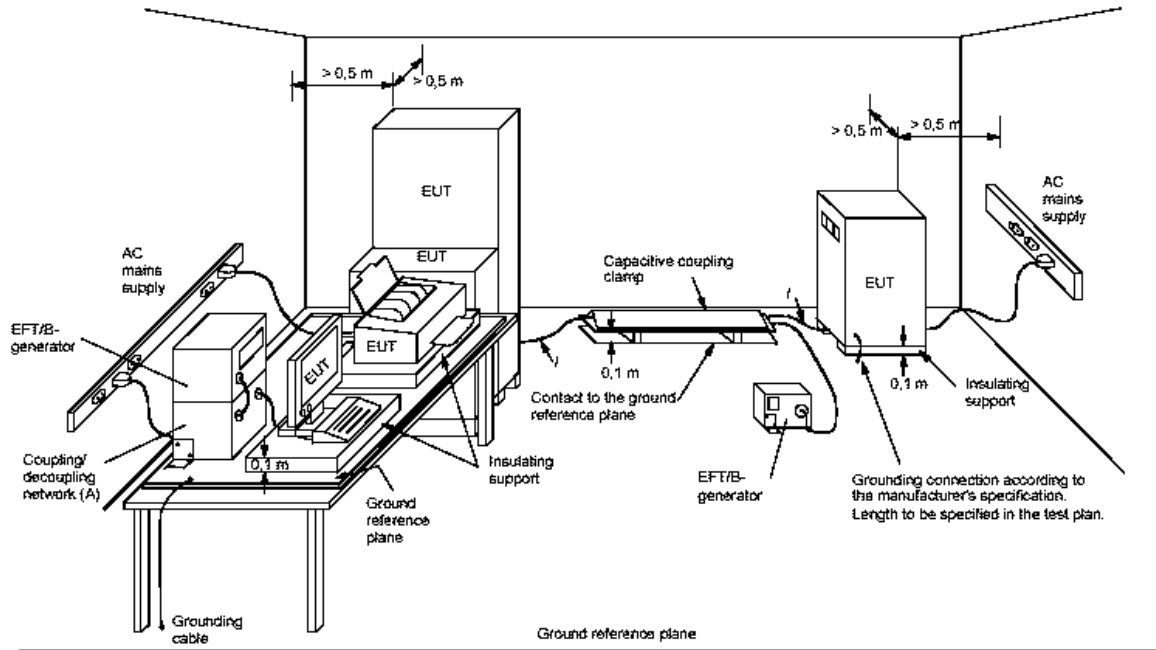

NOTE:
TABLETOP EQUIPMENT

The configuration consisted of a wooden table standing on the Ground Reference Plane and should be located 0.1m +/- 0.01m above the Ground Reference Plane. The GRP consisted of a sheet of aluminum (at least 0.25mm thick and 2.5m square) connected to the protective grounding system. A minimum distance of 0.5m was provided between the EUT and the walls of the laboratory or any other metallic structure.

FLOOR STANDING EQUIPMENT

The EUT installed in a representative system as described in section 7 of IEC 61000-4-4 and its cables, were isolated from the Ground Reference Plane by an insulating support that is 0.1-meter thick. The GRP consisted of a sheet of aluminum (at least 0.25mm thick and 2.5m square) connected to the protective grounding system.



4.4.6 TEST RESULTS

TEST MODE	See section 2.2	TEST VOLTAGE	See section 2.2
ENVIRONMENTAL CONDITIONS	22.6DEG. C, 54.5% RH	TESTED BY: Wang	

Pulse Voltage	<u>2.0</u> kV	<u> </u> kV	<u> </u> kV	<u> </u> kV
Pulse Polarity	+	-	+	-
DC Line	A	A	/	/

NOTE: A: There was no change compared with initial operation during the test.



4.5 IMMUNITY TO CONDUCTED DISTURBANCES INDUCED BY RF FIELDS (CS)

4.6.1 TEST SPECIFICATION

Basic Standard:	IEC 61000-4-6
Frequency Range:	0.15 MHz - 80 MHz
Field Strength:	10V _{r.m.s}
Modulation:	1kHz Sine Wave, 80%, AM Modulation
Frequency Step:	1 % of fundamental
Coupled Cable:	DC Power Line
Coupling Device:	Clamp

4.6.2 TEST INSTRUMENTS

Equipment	Manufacturer	Model No.	Serial No.	Last Cal.	Next Cal.
Signal Generator	Rohde&Schwarz	SMB 100A	102382	Mar. 12,20	Mar. 11,21
CDN	Luthi	L-801M2/M3	2015	Sep. 18,19	Sep. 17,20
CDN(AUX)	TESEQ	CDN M016	27452	Sep. 18,19	Sep. 17,20
CDN	TESEQ	T200A	26944	Mar. 13,20	Mar. 12,21
CDN	TESEQ	T400A	26536	Mar. 13,20	Mar. 12,21
CDN	TESEQ	ST08A	32256	Mar. 13,20	Mar. 12,21
6dB 150Watt Attenuator	Bird	150-A-FFN-06	1507	Sep. 18,19	Sep. 17,20
Power Amplifier	PRANA	DR 220	1512-1788	NA	NA
Electromagnetic Injection Clamp	Luthi	EM101	35640	Sep. 25,19	Sep. 24,20
Test Software	Tonscend	TS+	2.5.0.0	N/A	N/A
Test Software	ADT	BVADT_CS_V 7.6.2	N/A	N/A	N/A
Audio analyzer	Rohde&Schwarz	UPV	101346	Jun. 13,19	Jun. 12,20
EAR SIMULATOR	B&K	4192	2764719	Aug. 10,19	Aug.09,20
Sound Calibrator	B&K	Type 4231	2463874	Jul. 25,19	Jul.24,20
Conditioning Amplifier	B&K	2690A0S2	2437856	Sep. 10,19	Sep.09,20
Universal Radio Communication Tester	Rohde&Schwarz	CMU 200	119669	Mar. 12,20	Mar. 11,21

- NOTES:** 1. The test was performed in CS test room.
 2. The calibration interval of the above test instruments is 12 months and the calibrations are traceable to CEPREI/CHINA, GRGT/CHINA and NIM/CHINA.



4.6.3 TEST PROCEDURE

- a. The EUT shall be tested within its intended operating and climatic conditions.
- b. An artificial hand was placed on the hand-held accessory and connected to the ground reference plane.
- c. The test shall be performed with the test generator connected to each of the coupling and decoupling devices in turn, while the other non-excited RF input ports of the coupling devices are terminated by a 50-ohm load resistor.
- d. The frequency range is swept from 150 kHz to 80 MHz, using the signal level established during the setting process and with a disturbance signal of 80 % amplitude. The signal is modulated with a 1 kHz sine wave, pausing to adjust the RF signal level or the switch coupling devices as necessary. Where the frequency is swept incrementally, the step size shall not exceed 1 % of the preceding frequency value.
- e. The dwell time of the amplitude modulated carrier at each frequency shall not be less than the time necessary for the EUT to be exercised and to respond, but shall in no case be less than 0,5 s. The sensitive frequencies (e.g. clock frequencies) shall be analyzed separately.
- f. Attempts should be made to fully exercise the EUT during testing, and to fully interrogate all exercise modes selected for susceptibility.

4.6.4 DEVIATION FROM TEST STANDARD

No deviation.



4.6.5 TEST SETUP

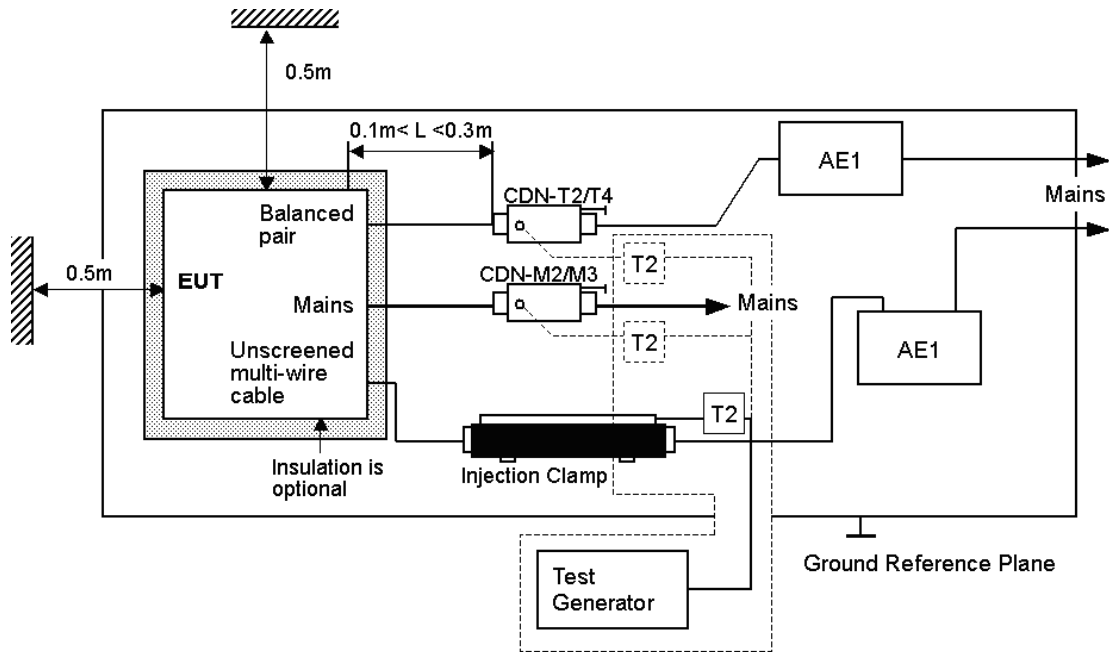

NOTE: The EUT clearance from any metallic obstacles shall be at least 0.5m.

All non-excited input ports of the CDNs shall be terminated by 50Ω loads.

NOTE:

FLOOR-STANDING EQUIPMENT

The equipment to be tested is placed on an insulating support of 0.1 meters height above a ground reference plane. All relevant cables shall be provided with the appropriate coupling and decoupling devices at a distance between 0.1 meters and 0.3 meters from the projected geometry of the EUT on the ground reference plane.



4.6.6 TEST RESULTS

TEST MODE	See section 2.2	TEST VOLTAGE	See section 2.2
ENVIRONMENTAL CONDITIONS	25.1deg. C, 51.6% RH	TESTED BY: Dragon	

Voltage (V)	Test Frequency Note ^{#1} (MHz)	Tested Line	Injection Method.	Test Result	Remark
10	0.15 – 80	DC Line	Clamp	A	N/A

Note^{#1}: Tested Israel SII Frequencies 0.2,0.53,1,1.5,7.1,13.56,21,27.12,40.68,65,68 MHz

NOTE: A: There was no change compared with initial operation during the test.



4.6 POWER FREQUENCY MAGNETIC FIELD IMMUNITY TEST

4.6.1 TEST SPECIFICATION

Basic Standard:	IEC 61000-4-8
Frequency Range:	50Hz
Field Strength:	30A/m
Observation Time:	5 minute
Inductance Coil:	Rectangular type, 1mx1m

4.6.2 TEST INSTRUMENTS

Equipment	Manufacturer	Model No.	Serial No.	Last Cal.	Next Cal.
Magnetic Field Tester	HAEFELY	MAG100.1	150579	Sep. 18,19	Sep. 17,20
Test Software	N/A	N/A	N/A	N/A	N/A

- NOTES:** 1. The test was performed in Shielding Room 843.
 2. The calibration interval of the above test instruments is 12 months and the calibrations are traceable to CEPREI/CHINA, GRGT/CHINA and NIM/CHINA.

4.6.3 TEST PROCEDURE

- The equipment is configured and connected to satisfy its functional requirements.
- The power supply, input and output circuits shall be connected to the sources of power supply, control and signal.
- The cables supplied or recommended by the equipment manufacturer shall be used. 1 meter of all cables used shall be exposed to the magnetic field.

4.6.4 DEVIATION FROM TEST STANDARD

No deviation.



4.6.5 TEST SETUP

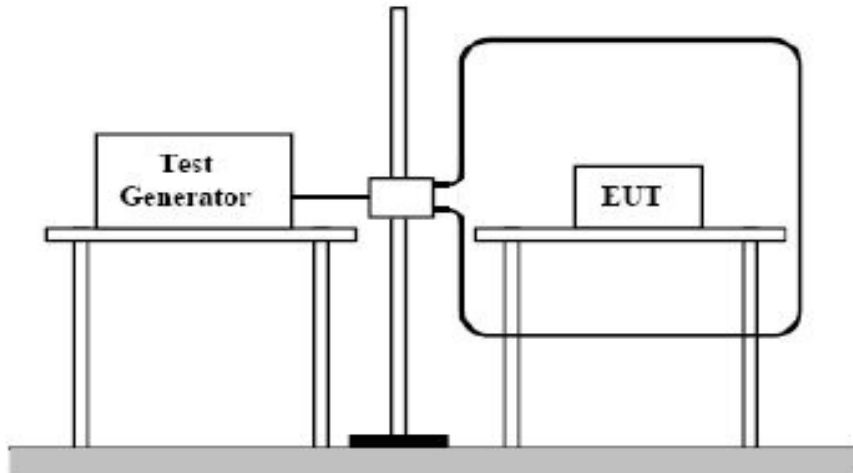

NOTE:

TABLETOP EQUIPMENT

The equipment shall be subjected to the test magnetic field by using the induction coil of standard dimension (1 m x 1 m). The induction coil shall then be rotated by 90 degrees in order to expose the EUT to the test field with different orientations.

FLOOR-STANDING EQUIPMENT

The equipment shall be subjected to the test magnetic field by using induction coils of suitable dimensions. The test shall be repeated by moving and shifting the induction coils, in order to test the whole volume of the EUT for each orthogonal direction. The test shall be repeated with the coil shifted to different positions along the side of the EUT, in steps corresponding to 50 % of the shortest side of the coil. The induction coil shall then be rotated by 90 degrees in order to expose the EUT to the test field with different orientations.



4.6.6 TEST RESULTS

TEST MODE	See section 2.2	TEST VOLTAGE	See section 2.2
ENVIRONMENTAL CONDITIONS	22.7deg. C, 50.6% RH	TESTED BY: Wang	

Magnetic field direction	Testing result	Remark
X - Axis	A	30A/m
Y - Axis	A	30A/m
Z - Axis	A	30A/m

NOTE: A: There was no change compared with initial operation during the test.



5 PHOTOGRAPHS OF THE TEST CONFIGURATION

RADIATED EMISSION TEST (30MHz~1GHz)

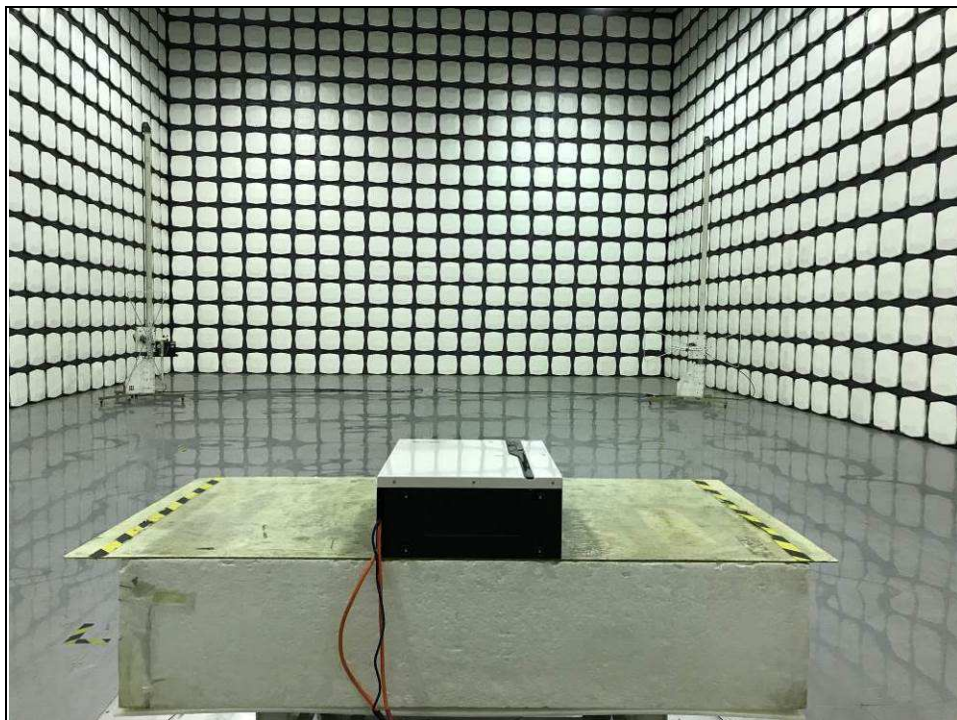
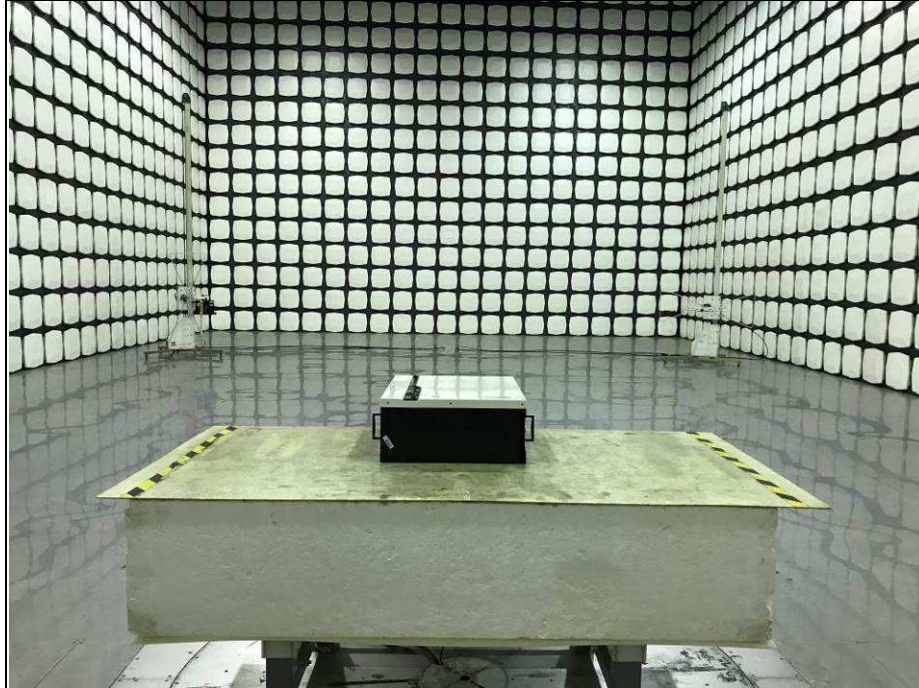



**BUREAU
VERITAS**

Test Report No.: CE200109N021-2

ESD TEST



RS TEST

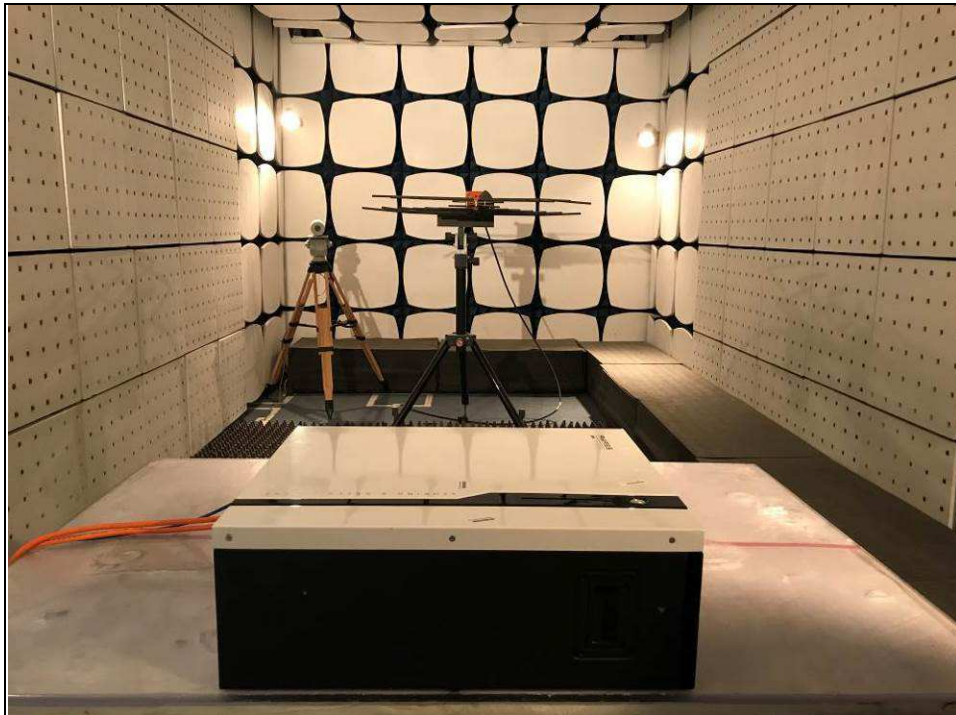

Bureau Veritas Shenzhen Co., Ltd.
Dongguan Branch

No. 96, Guantai Road (Houjie Section),
Houjie Town, Dongguan City, Guangdong
Province. 523942. People's Republic of
China.

Tel: +86 769 8998 2098
Fax: +86 769 8593 1080
Email: customerservice.dg@cn.bureauveritas.com



**BUREAU
VERITAS**

Test Report No.: CE200109N021-2

EFT TEST

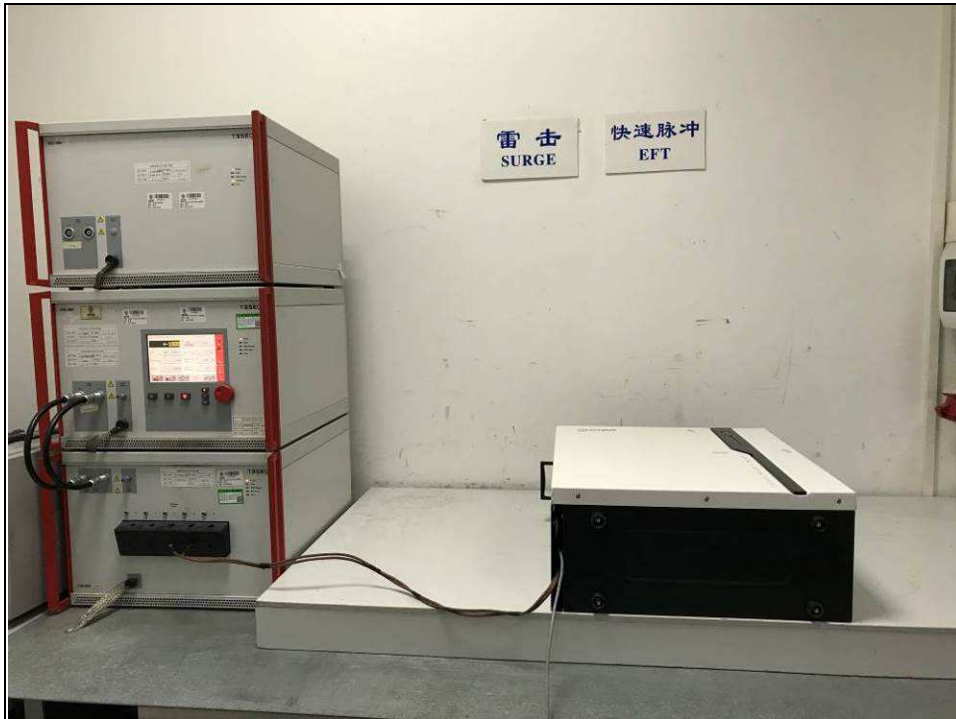

CONDUCTED SUSCEPTIBILITY AT DC LINE TEST



Bureau Veritas Shenzhen Co., Ltd.
Dongguan Branch

No. 96, Guantai Road (Houjie Section),
Houjie Town, Dongguan City, Guangdong
Province. 523942. People's Republic of
China.

Tel: +86 769 8998 2098
Fax: +86 769 8593 1080
Email: customerservice.dg@cn.bureauveritas.com



**BUREAU
VERITAS**

Test Report No.: CE200109N021-2

POWER-FREQUENCY MAGNETIC FIELDS TEST

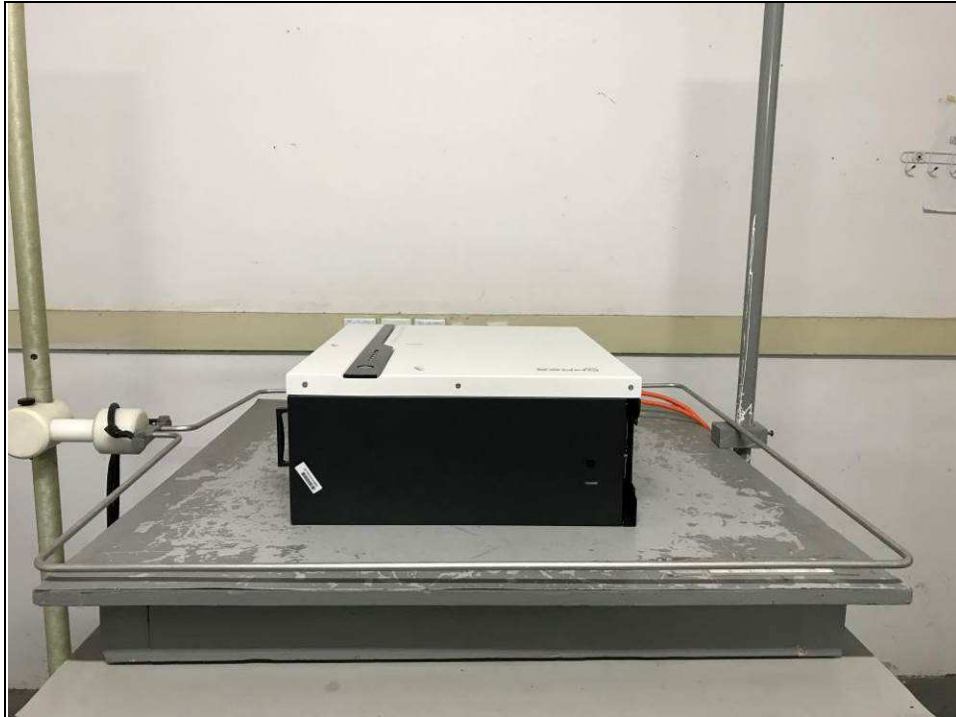



**BUREAU
VERITAS**

Test Report No.: CE200109N021-2

6 APPENDIX A – MODIFICATIONS RECORDERS FOR ENGINEERING CHANGES TO THE EUT BY THE LAB

No any modifications were made to the EUT by the lab during the test.

---END---